

### Front panel

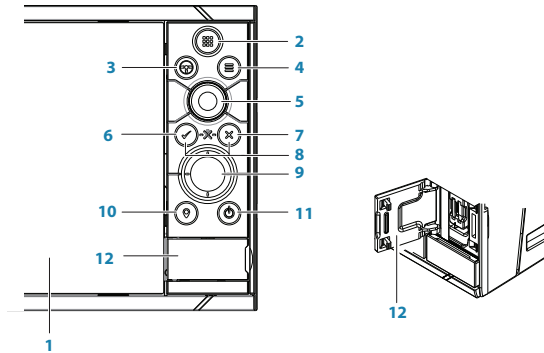

No.	Description
1	Touch screen.
2	<b>Pages/Home key</b> - press to open the Home page for page selection and setup options.
3	<b>WheelKey</b> - user configurable key, refer to Operator manual. <i>Default without autopilot in system:</i> Short press toggles between panels on split screen. Long press maximizes active panel on split screen. <i>Default with autopilot in system:</i> Short press opens autopilot controller and places autopilot in standby mode. Long press toggles between panels on split screen.
4	<b>Menu key</b> - press to display the active panel's menu.
5	<b>Rotary knob</b> - turn to zoom or scroll the menu, press to select an option.
6	<b>Enter key</b> - press to select an option or save settings.
7	<b>Exit key</b> - press to exit a dialog, return to previous menu level, and clear cursor from panel.
8	<b>MOB keys</b> - press simultaneously the <b>Enter</b> and <b>Exit</b> keys to create a MOB (Man Over Board) at the vessel's position.
9	<b>Arrow keys</b> - press to activate cursor or to move cursor. Menu operation: press to navigate through menu items and to adjust a value.
10	<b>Mark key</b> - press to place waypoint at vessel position, or at cursor position when cursor is active.
11	<b>Power key</b> - press and hold to turn the unit ON/OFF. Press once to display the System control dialog, additional presses will toggle through 3 default dimming levels.
12	Card reader door

## System Control dialog

Used for quick access to system settings.

Activate the dialog by pressing the **Power** key, or by swiping from the top of the screen.



→ **Note:** The content of the System Control dialog depends on connected equipment and active panel.

## Home page

Activate the Home page by pressing the **Home** key.

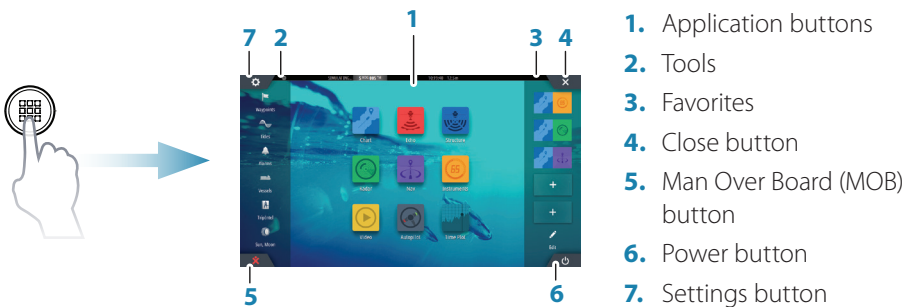

## Application pages

Activate an application page:

- Tap the application button (full page panel), or
- tap a favorites button, or
- press and hold an application button to select a predefined split page.



## Adjust panel size

You can adjust the panel sizes in a split page.

1. Tap the adjust split button in the System Control dialog to show the resize icon
2. Drag the resize icon to set preferred panel size
3. Save the changes by tapping the screen.



## Edit a favorite page

Enter the Favorites edit mode:

- Tap the Edit icon, or
- press and hold a favorite button.

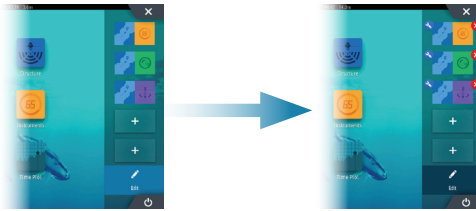

Edit favorite page



Delete favorite page



Add new favorite page

Edit an existing favorite page or configure a new page by dragging panel icons into or out from the preview area.

Save the changes by tapping the **Save** button.

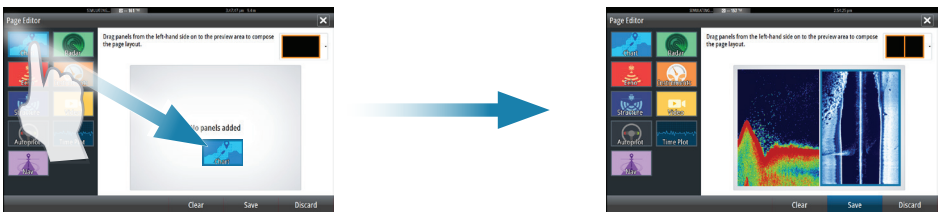

## Instruments bar

Tap the Instrument bar button in the System Control dialog to turn the bar on/off.

To edit the content of the Instrument bar:

1. Tap the Instrument bar to make it active
2. Select the edit option from the menu
3. Tap the item you want to change
4. Select the information you want to display in the Instrument bar
5. Save the changes by selecting the save option in the menu.

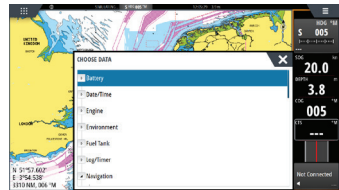
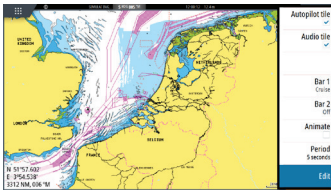

## Charts



A

- Zoom the chart by using spread or pinch gestures, by using the zoom buttons (A), or by turning the **Rotary** knob.
- Move the view in any direction by panning the chart.
- Display information about a chart item by tapping the item.

## Waypoints

➔ **Note:** With cursor inactive, the waypoint will be placed at vessel's position. With cursor active, the waypoint will be placed at selected cursor position.

To create a waypoint:

- Press the **Mark** key to instantly add a waypoint.
- Press the **Rotary** knob, or use the new waypoint option in the menu to open a New waypoint dialog.



## Route

To create a route:

1. Tap the screen or use the arrow keys to activate cursor mode
2. Select the new route option in the menu
3. Tap the chart to position the first routepoint. Alternatively, use the arrow keys to position the routepoint, then press the **Rotary** knob to confirm the position.
4. Repeat point 3 to position additional routepoints
5. Save the route by selecting the save option from the menu.

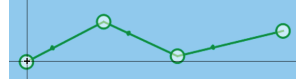

## Navigating

To navigate to cursor position:

1. Tap the screen or use the arrow keys to position the cursor
2. Select the goto cursor option in the menu.

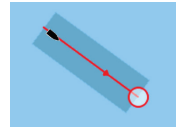

To navigate a predefined route:

- Tap the route to make it active, then select the goto route option in the menu, or
- select the route from the Routes dialog, then select the goto option in the dialog.

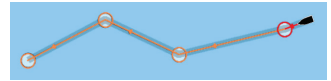

## Overlay

Add a radar, weather, SonarChart Live (Navionics' charts only), or StructureScan overlay on the chart by selecting the option in the menu.

## Echosounder

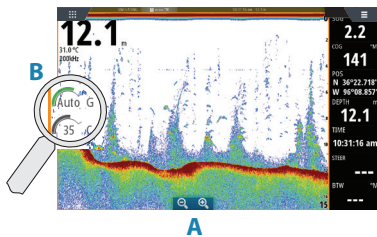

- Zoom the image by tapping the zoom buttons (**A**) or by turning the **Rotary** knob.
- View echosounder history by panning the image.
- Adjust gain and color from the slide bar, displayed by tapping the gain or color icon (**B**), or by pressing the **Rotary** knob.
- Toggle auto gain on/off from the menu, or by pressing and holding the **Rotary** knob.

Toggle available echosounder frequencies from the menu. Available options depend on type of transducers connected to the system.

Single frequency transducers	50 kHz	Lower resolution images. Best performance in deep water
	83 kHz	Greater water coverage
	200 kHz	High resolution images and better target separation in shallow water
Chirp transducers	Low CHIRP	Lower resolution images. Best performance in deep water
	Medium CHIRP	Better depth penetration than High CHIRP, but with minimal loss of target definition
	High CHIRP	High resolution images and better target separation in shallow water

## StructureScan



- Select Downscan or Sidescan view from the menu
- Zoom the image by tapping the screen to position the cursor, then tap the zoom buttons (A) or turn the **Rotary** knob
- Adjust contrast manually from the slide bar, displayed by tapping the Contrast icon (B), or by pressing the **Rotary** knob

Toggle between available StructureScan frequencies from the menu.

455 kHz	Excellent resolution and greater range than 800 kHz
800 kHz	Better definition than 455 kHz at shallower depths

## ForwardScan

- Adjust depth, range and noise rejection from the menu.
- Start recording ForwardScan logs from the menu.
- Use the heading extension to monitor ForwardScan on the chart panel. Heading extension colors are based on the ForwardScan alarm values.

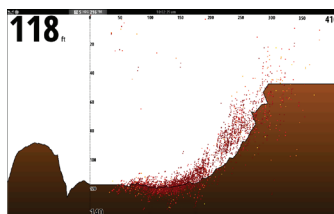

# Autopilot

You can activate the autopilot from any panel.

1. Press the Autopilot tile in the Instrument bar or the **WheelKey** when this is configured for Autopilot control
2. Select the autopilot mode in the Autopilot pop-up

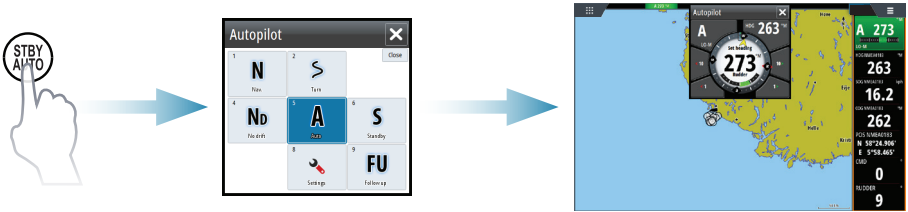

<b>S</b>	Standby	Autopilot is passive. Used when manually steering at the helm
<b>FU</b>	Follow-up	Manual steering. The rudder angle is set by the <b>Rotary</b> knob or by another FU unit
<b>NFU</b>	Non-Follow-up	Manual steering. The rudder movement is controlled by the <b>Port</b> and <b>Starboard</b> buttons in the Pilot pop-up, or by another NFU unit
<b>A</b>	Auto	Automatic steering, maintaining the set heading
<b>Nd</b>	NoDrift	Automatic steering, keeping the vessel on a straight bearing line by compensating for drift
<b>N</b>	Navigation	Automatic steering, navigating the vessel to a specific waypoint or through a route using GPS data
<b>W</b>	Wind *	Automatic steering, maintaining the set wind angle
<b>Wn</b>	Wind navigation *	Automatic steering, navigating the vessel to a specific waypoint or through a route using both wind and GPS data

\* Only available if the boat type is set to Sailboat.

→ **Note:** You switch the autopilot to Standby mode from any automatic mode by a short press on the **WheelKey** configured for Autopilot control.

## Adjust set heading / course / wind angle



Adjust set heading (Auto mode), set wind angle (Wind mode) and set course (NoDrift mode):

- Tap the **Port** or **Starboard** button in the autopilot pop-up, or
- turn the **Rotary** knob.

# Radar

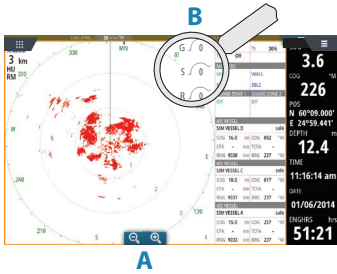

- Turn the radar transmitting on/off from the menu.
- Set the range by using the zoom icons (A) or by turning the **Rotary** knob.
- Adjust gain, sea clutter and rain clutter settings from the slide bar, displayed by tapping the settings icons (B), or by pressing the **Rotary** knob.

# Audio

Activate the Audio overlay by tapping the **Audio** tile in the Instrument bar.



# Positioning a MOB mark

Save a Man Over Board (MOB) mark at vessel position by tapping the  button on the Home page or by simultaneously pressing the **Enter** and **Exit** keys from the keypad.

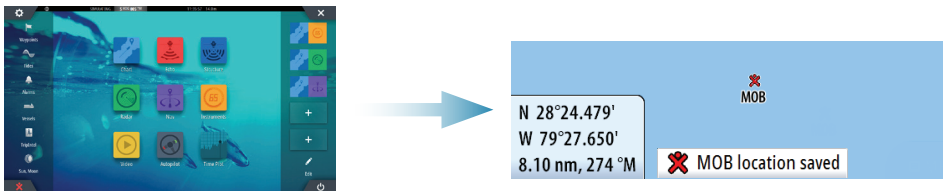

For more details, see the  NSS evo3 Operator manual.

